



For Earth, For Life
Kubota



ТРАКТОРЫ • НАВЕСНОЕ ОБОРУДОВАНИЕ • ОРИГИНАЛЬНЫЕ ЗАПАСНЫЕ ЧАСТИ

www.mosttechnics.ru

B

KUBOTA DIESEL TRACTOR B26

More versatile than most tractors in its class, the streamlined B26 is compact, yet has the power and high-end features you need to accomplish a wide array of tasks.



*This information is sourced from overseas and may not necessarily apply locally. It is essential that you confirm specifications and other information with your local Kubota dealer.

Increased Lifting Capacity and Height

The loader on the new B26 has a 500 kg heavy-duty lift capacity and a 2390 mm lifting height.

Console-mounted Loader Joystick

The loader joystick is mounted to the side console to give you better control of the B26's loader. This allows the operator to utilise multiple functions with ease.

Greater Horsepower

The 26HP diesel engine of the B26 powers the loader and backhoe through all kinds of heavy work.

Slanted Loader and Bonnet

The slanted boom and bonnet design of the B26 improves visibility, which is particularly useful when changing attachments or manoeuvring in tight places.

Skid Steer-type Quick Couplers

This loader feature, typically found on larger models, allows you to easily and quickly attach and detach a variety of front implements.



Whether you're using it for agricultural or commercial work, the new B26 offers the versatility and power you need. The B26 boasts features usually only found on larger tractor/loader/backhoes. With this tractor you'll discover increased loader lifting capacity, greater backhoe digging power and depth, more horsepower, a host of new features aimed at operator comfort and safety, and a striking new design. With the B26, we've worked hard to construct a compact machine that will make your work easier.

Joystick Armrest

Located next to the console-mounted loader joystick, this armrest helps to reduce arm movement and fatigue.

ROPS/FOPS

The Falling Object Protective Structure (FOPS), with its durable canopy, complements the ROPS offering added operator protection.

Increased Digging Capacity

Get more power and dig deeper. We've increased the bucket breakout force by 35% and the digging depth by more than 200 mm.

Curved Backhoe Boom

The arched design of the B26's backhoe boom helps operators avoid dig-area obstacles and easily reach maximum digging depth.

Backhoe Quick-Mount System

Attaching and detaching the backhoe has never been easier than with this quick-mount system.

3-Point Hitch

We've increased the lifting power of the B26's Category 1 3-point hitch by over 60%, offering greater versatility with implements.

Shown with optional equipment.

KUBOTA DIESEL TRACTOR NEW B26



Built specifically for loader and backhoe applications, the B26 features an integrated main frame to ensure durability. Its 26HP engine provides high power and torque rise as well as low noise. And, a 3-point hitch greatly improves the B26's versatility.

TRACTOR

A real workhorse with advanced features usually found only on larger models.

Some pictures are shown with optional equipment.

Engine

Tackle the toughest jobs with the B26's rugged 26HP diesel engine. It boasts an enviable combination of high power, high torque rise, low noise, low vibration and cleaner emissions. Easy to start on cold mornings, this high-output, liquid-cooled engine will prove both dependable and durable for years to come.



Slanted Boom and Bonnet Design

The slanted boom and bonnet of the B26 improves visibility over the bonnet. This helps you change attachments and get back to work quickly, and allows increased productivity in tight areas.

Integrated Main Frame

The reinforced integrated main frame of the B26 is performance matched to the loader and backhoe. This means that the structural integrity of the tractor is uncompromisingly sound and built to take on the stresses of repetitive loader and backhoe work.

3-Point Hitch

To give you the ability to take on bigger jobs, the lifting capacity of the B26's Category I 3-point hitch is 760 kg 600 mm behind the lift points. This will allow you to attach a wider variety of implements and larger implements, making you more productive.



Four Wheel Drive

Combined with the differential lock for the front axle, the B26's 4WD ensures virtually unstoppable performance under difficult conditions or on varying terrain.

Hydraulic Independent PTO

The Independent PTO keeps stopping to a minimum. With this handy feature, you can stay productive by engaging and disengaging the rear PTO without ever having to stop the tractor.





Headlights/Worklights

We've installed headlights and worklights to the canopy and ROPS respectively. The height of the headlights provides greater ground coverage during night work. The rear-mounted worklights shine brightly for backhoe or 3-point hitch work.

ROPS/FOPS

The Rollover Protective Structure (ROPS) and the Falling Object Protective Structure (FOPS) come standard on the B26. Besides protecting you from harm, the FOPS canopy also serves as a barrier between you and the elements.

Onboard conveniences and comforts make hard work easier.

Spark Arrestor

Mounted under the hood, the standard Spark Arrestor muffler ensures that you are safe when working around dry fields or grass.

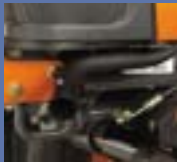

Engine Start Switch

We've moved the starter switch to the right side of the operator seat to make it easier to reach when you're operating the loader or the backhoe.



Deluxe Seat

We've installed more comfortable and ergonomic seats on the new B26. These new deluxe seats are more cushioned to reduce fatigue, even when working long hours.





From the brace-less loader frame to the Skid Steer-type quick coupler, everything about this loader is designed to improve productivity. The B26's loader offers increased lifting capacity and a greater lifting height. It also has a host of features designed to make loader use easier, including a mechanical spill guard and a console-mounted joystick and armrest.

LOADER

Let our new and improved loader lift your productivity to new heights.

Some pictures are shown with optional equipment.

Lifting Capacity and Height

The loader on the new B26 has a lift capacity of 500 kg. This allows you to handle heavy loads and gives you more power on any job. The lift height of 2390 mm is the best in class.



3rd Function Valve (optional)

The 3rd Function Auxiliary Hydraulic Valve allows you to do more than ever. Optional front remotes and the Skid Steer-type quick coupler enable the use of a 4-in-1 bucket, grapple bucket and various other hydraulically controlled implements. The 3rd Function Valve can be easily activated with a button located on the grip of the loader joystick.

Front Guard

This rugged front guard protects the B26's most vital parts in case of a collision. It also perfectly complements the new slanted hood design.



Skid Steer-type Quick Couplers

A high-end feature, the Skid Steer-type quick couplers, allows you to easily change between implements like a pallet fork, bale spear, 4-in-1 bucket, grapple bucket, blade or post-hole digger without tools. Simply set the two locking levers and attach hose couplers, and you're on your way.



Built-in Loader Valve

We've concealed the B26's loader valve and mounted it directly to the tractor. In doing so, we've not only protected the valve, thus increasing its longevity, we've also improved operator visibility and cleaned up the overall design of the machine.

Mechanical Spill Guard

The B26's Mechanical Spill Guard tilts the bucket forward as the loader is raised, thus reducing the spillage of the bucket's contents. This makes filling and dumping easier and increases efficiency.



Lubrication Points

Lubrication points on the loader are conveniently located, eliminating the need to reposition the loader during lubrication.

Enclosed Hoses

The loader's hydraulic hoses are routed through the B26's boom. This not only protects them and adds to their longevity, it also gives operators a cleaner and clearer line of sight in front of the tractor.

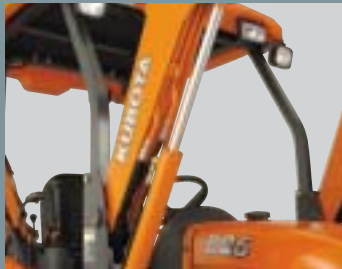

Features designed to make long workdays seem shorter.

Brace-less Frame

The brace-less loader frame design improves visibility and offers easier access under the bonnet.

Bucket-level Indicator

The B26 features a new and improved bucket-level indicator. Located on the loader lift arm, the rod indicator of the B26 gives you the ability to check level when you're using other implements like the pallet fork, and allows you to more easily check level when using the bucket.

Console-mounted Loader Joystick and Armrest

Just like larger tractors, the loader joystick is mounted on the console at the operator's right side. Positioned next to the joystick, a sturdy armrest reduces arm movement and fatigue, providing the comfort and support you need for long workdays.

Shown with optional loader 3rd function controls.



We've improved the B26's backhoe in many ways. We've given it more power, increased its digging depth and added a host of new features, including options for making the backhoe easier to use and more versatile. All in all, the B26 backhoe promises more performance than you would have ever dreamed in such a compact package.

BACKHOE

Built stronger, longer and more versatile than ever, to take on backhoe jobs big and small.

Some pictures are shown with optional equipment.

Curved Backhoe Boom

The curved boom of the B26's backhoe helps you to avoid dig area obstacles, such as large rocks, and to achieve maximum digging depth with a minimum trench cut. It also allows you to more easily place the bucket contents in the centre of a truck bed, as the curvature helps you to clear the truck's sideboards.

Protected Hydraulic Hoses

To better protect and increase the life of the hydraulic hoses, we've routed them through the boom and arm. This routing also helps to offer greater visibility and deliver an overall cleaner backhoe design.



Reversible Seat

Simply lift a lever and rotate the B26's deluxe seat from forward facing to rear facing and back again. It makes switching to backhoe operation a snap.



Hydraulic Cylinder

High-quality chrome plating of our backhoe's hydraulic cylinders means that they are less prone to rust, offer increased durability, and better sealing performance.

Stabiliser Lifting Capacity

We've increased the stabiliser lift capacity to give you greater control on any terrain. The improved capacity results in better balance, which reduces unwanted settling. It also means more strength—rear tyre lift is possible even while the tractor is idling.



20.3° Angle of Departure

High ground clearance provides a generous 20.3 degree angle of departure. This allows the B26 to load quickly onto trailers, easily ascend inclines and prevent damage to curbs while you move from job to job.



Digging Capacity

Here's everything you could want in a backhoe—more power and the ability to dig deeper. The B26 offers more than 1815 kg of bucket breakout force and a digging depth of 2540 mm. And best of all, you get all this in a surprisingly compact tractor.



Precise Inching Performance

Experience smooth and precise movement of the arm and boom thanks to our high-performance inching valve. This comes in handy when simultaneous arm and boom movements are required or when using the backhoe to "finish" jobs.

Make any job an easy job with these options and features.



3-Point Hitch Storage

This standard, Category I 3-point hitch gives you excellent versatility and compactly folds up in the B26's convenient storage space when not in use.

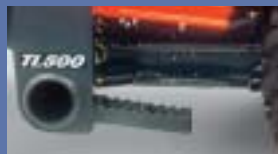

Hydraulic Independent PTO

The independent rear PTO allows you to engage and disengage it without ever having to stop the tractor.



Quick Mount Attach/Detach

Our four-point attach/detach allows operators to quickly remove the backhoe from the integrated frame and install the Category I 3-point hitch for implement use.

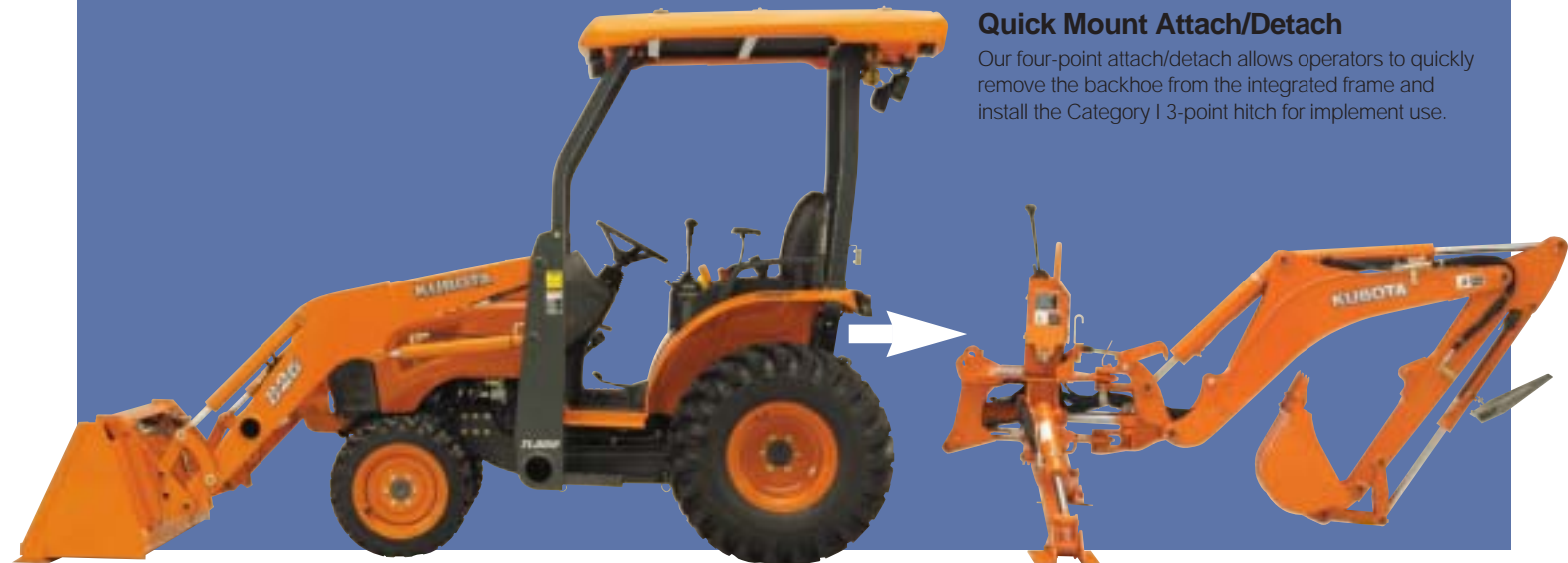



Implements are the key to getting the most out of your B26 tractor/loader/backhoe. Remove the backhoe and attach our 3-point hitch to use a slasher, rotary hoe, rotary cutter, power rake and other PTO-driven implements. Or use our Skid Steer-type quick coupler to attach implements like a pallet fork or bale spear to the front.

VERSATILITY

The adaptable and resourceful B26 is equipped to do it all.



SLASHER



ROTARY CUTTER

TRACTOR SPECIFICATIONS

Engine	Gross power (SAE)	26 HP (19.4 kW)
	Net power (SAE)	23.3 HP (17.4 kW)
	Total displacement	1123 cm ³
	No. of cylinders	3
	Rated speeds	2800 rpm
Max. PTO power		19.5 HP (14.5 kW)
Fuel tank capacity		31 liters
Tire size	Front	23 × 8.50–14R4 (IND)
	Rear	12.4–16R4 (IND)
Wheelbase		1581 mm
Tread	Front	905 mm
	Rear	1050 mm
Weight with Loader, Backhoe and ROPS/FOPS^{*1)}		1815 kg
Min. turning radius (w/ brake)		2.5 m
Rear PTO		Live Independent, 9.0 r/s (540 rpm)
Clutch		N/A
Power steering		Hydrostatic
Transmission	Type	HST
	No. of speeds	Forward 3, Reverse 3
	Max. travelling speed	17.8 km/h
	Range shift lever position	Seat side, right
Brake type		Wet disc
Hydraulic system	Pump capacity ^{*2)}	42.3 l/min.
	3-point hitch lift capacity at 24 in. (610 mm) behind lift point	760 kg
	Position control	Standard
3-point hitch (Category I)		Standard
ROPS		4-post, Standard
FOPS		Standard
Others	Loader-integrated reinforced frame	Standard
	Reversible seat	Standard
	Tilt steering	Standard
	Muffler	Enclosed (w/ spark arrestor)
	Cup holder	Standard
	Engine start key & Hand throttle	Seat side, right
	Lights	F2, R2, Standard
	Armrest	Standard

^{*1)} With 60" loader quick attach bucket, 18" backhoe bucket and standard tyres.

^{*2)} 7.0 GPM for loader/backhoe/3-point hitch, 4.2 GPM for backhoe boom swing, 6.2 GPM for power steering.

LOADER SPECIFICATIONS

Lift capacity to max. height at bucket bottom mid point: ... 500 kg
 Lift capacity to max. height at pivot pin: ... 590 kg
Breakout force at pivot pin:10417 N
Control valve:One detent float position
 power beyond circuit

Net weight (Approx.): 285 kg
Auto-levelling mechanism:Mechanical spill guard

Operating Dimensions:

A. Maximum lift height to pivot pin2400 mm
 B. Clearance with bucket dumped1778 mm
 C. Reach at maximum height 567 mm
 D. Maximum dump angle 45 deg.
 E. Reach with bucket on ground1561 mm
 F. Bucket rollback angle 46 deg.
 G. Digging depth 177 mm
 H. Overall height in carrying position ...1258 mm

Performance Ratings (No Load)

Raise to full height:3.6 sec.
Lowering time self level valve:2.4 sec.
Attachment rollback time:3.4 sec.
Attachment dumping time:1.8 sec.

^{*}Tyres applied: 27×10.5-15R4 (Front) and 15–19.5R4 (Rear)

BACKHOE SPECIFICATIONS

Digging force using bucket
 cylinder (approx.)18731 N
 Digging force using dipperstick
 cylinder (approx.) 9444 N
 Trunnion type boom swing mechanism ... Two cylinders

Operating Dimensions:

A. Transport height 2264 mm
 B. Stabiliser spread-transport 1347 mm
 C. Ground clearance 287 mm
 E. Overall width 1365 mm
 F. Digging depth, maximum 2535 mm
 G. Digging depth, 2ft. flat bottom 2498 mm
 H. Digging depth, 8ft. flat bottom 1957 mm
 J. Operating height, fully raised 3298 mm
 K. Loading height 1963 mm
 L. Loading reach 1324 mm
 M. Reach from swing pivot 3400 mm
 N. Swing pivot to rear axle centre line ... 855 mm
 P. Bucket rotation181.2 deg.
 X. Swing arc180 deg.
 R. Stabiliser spread-operating 2116 mm
 A3. Angle of departure per SAE J1234 ... 20.3 deg.
 U. Levelling angle 10.7 deg.

^{*}The specifications are taken with KUBOTA's B26 tractor.
 (Tire size: Front 23×8.50-14R4, Rear 12.4–16R4)

The company reserves the right to change the above specifications without notice.

This brochure is for descriptive purposes only. Please contact your local Kubota dealer for warranty information.

Some of the items pictured in this brochure are optional, and not standard equipment.

For your safety, KUBOTA strongly recommends the use of a Rollover Protective Structure (ROPS) and seat belt in almost all applications.



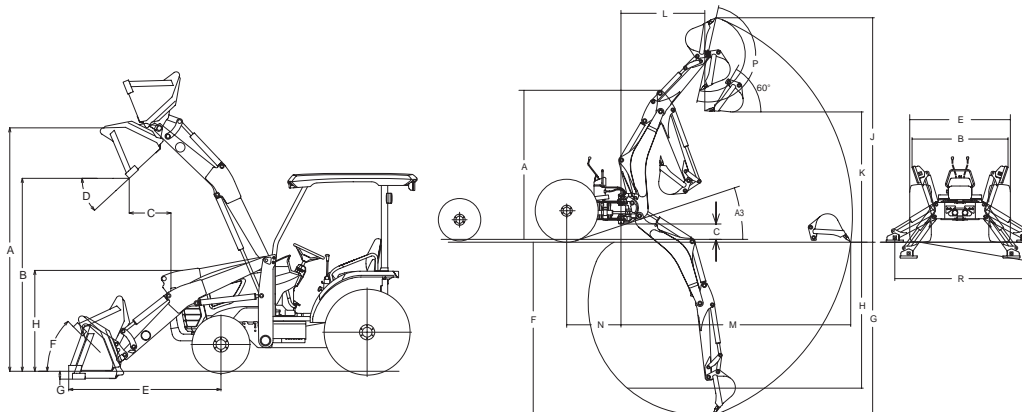

For complete operational information, the operator's manual should be consulted.



©2018 Kubota Corporation

Kubota

МОСТ ГРУПП

121357. Москва, ул. Козлова 30
Тел. +7 495 198 0175
Тел. +7 985 773 7851    
Факс +7 495 443 7000
E-mail sales@mosttechnics.ru
Http www.mosttechnics.ru

**Kubota
Genuine Parts**
for maximum
performance,
durability and
safety

