

ORIGINAL PARTS CATALOGUE

VERSION 2023



WHERE TO FIND PRODUCT INFORMATION?

Information such as Product Name, Product PN, Product Serial Number can be found directly on the machine sign located on the product itself.

Have a look in the user manual to find out where the machine sign is located.

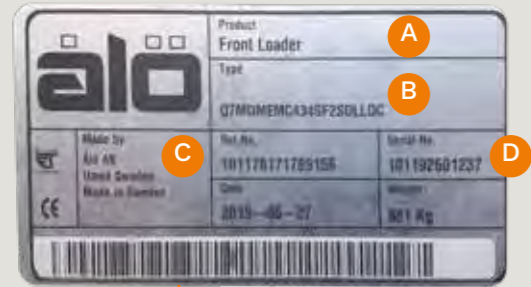

Loader machine sign

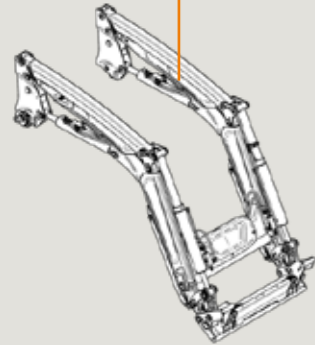

- A** Product Name
- B** Product Code
- C** Product Part Number
- D** Product Serial Number

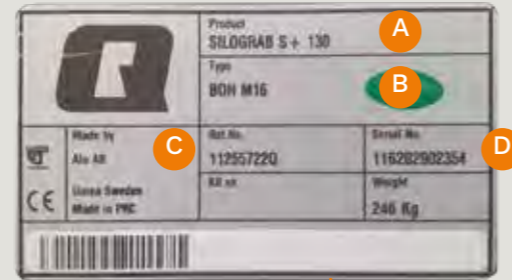

Implement machine sign

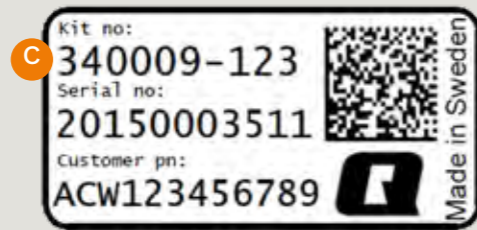
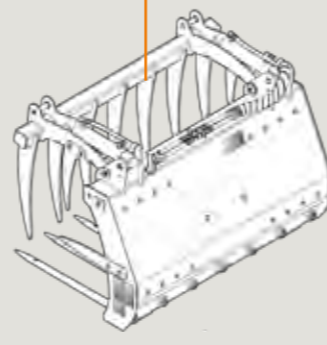

QCS control system machine sign

WHERE TO FIND ITEM PART NUMBER?

You can find the part number stamped or marked on some of our products. See below for examples.

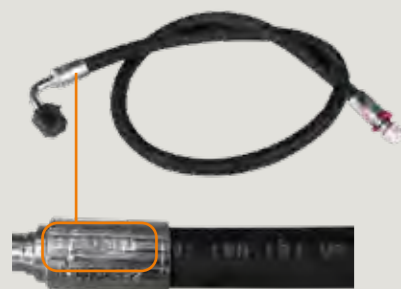

Hose PN stamped on the crimping

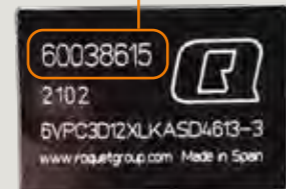

Q-series 3rd service block item sign



QCS Valve item sign



Control cable PN stamped on the cable itself

Decals with PN on Subframe components

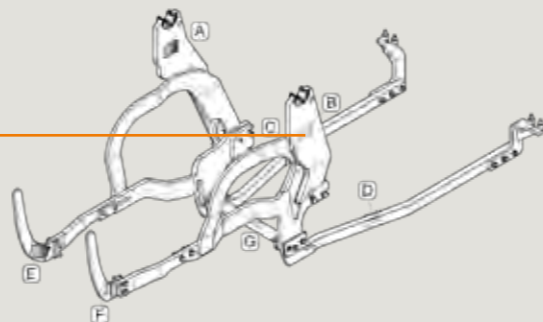

Original Parts by Quicke

CONTENTS

How to find spare parts on our website	4 – 5
Q-companion	6
Parts high lights	7
LoaderLight™	7
SoftDrive	7
Selecto Fix	7
Spare Parts	8 – 34
QCS parts	8 – 9
Joystick parts	10
Control cables	11 – 13
Pins	13 – 15
Bushings	16
Loader locking pins	16 – 17
Service & Maintenance	18 – 19
Loader Service Suitcase	20
Quicke Service Tool	21
New QCS Service Suitcases	21
Sealing kits to cylinders	22
Quick couplings	23
Bearings	23
Plastic spacer	24
Holder kit	24
Gas spring	24
Plastic covers	25
Electric Connectors	26 – 27
Part shelf	28
Accumulators	29
Paint	29
Kits for loaders produced before 2017	30 – 31
Tines	32
Bucket Teeth	33
Cutting Edges	33
Knives for Silocut	34
Pallet fork locking pins	34
Hooks	34
Cylinder stop	34
Original parts by Quicke	35



HOW TO FIND SPARE PARTS FOR QUICKE OR TRIMA PRODUCTS

Spare parts for Quicke or Trima products can be found in the online spare parts catalogue website: www.parts.quicke.nu

There are different sections according product types where you can either navigate to find the parts you need or type in what you are looking for in the searching bar located at the top of the webpage.

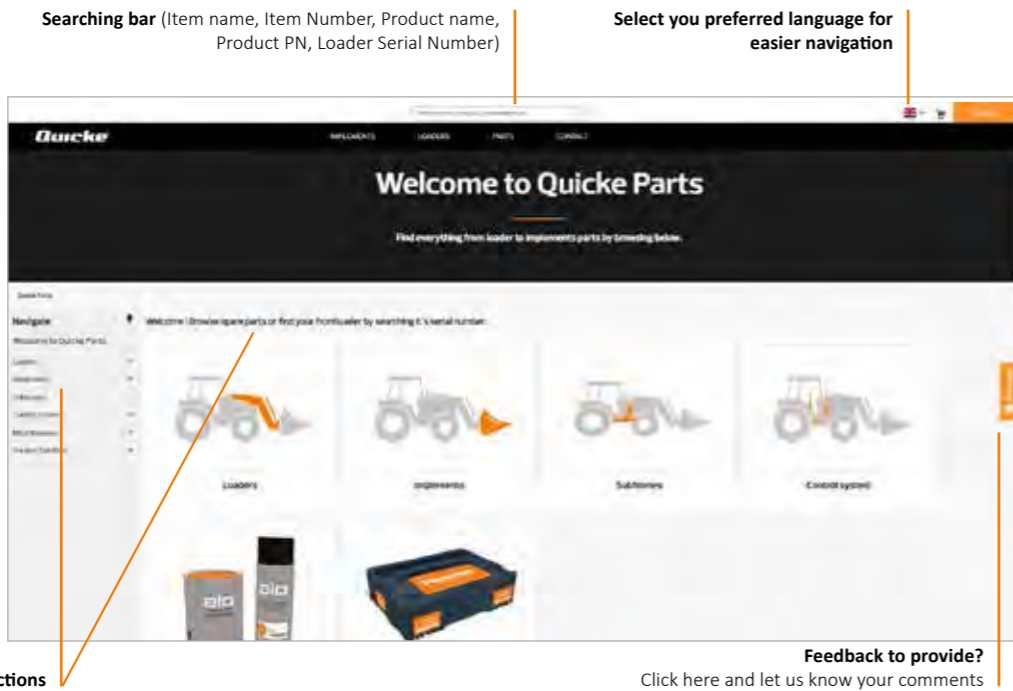

Searching bar function

Searching bar can be used to search in many different ways. You can search by Item name, Item number, Product name, Product PN, and even by Loader serial number. Type in what you're looking for to see the results.

Search by part number

1. Type in part number in the searching bar
2. Click on the result; system will show where the item is used
3. Click on "Path" to access to the dedicated parts table



Search by loader serial number

1. Type in the loader serial number in the searching bar
2. Click on the result to see loader production date and factory installed equipment
3. Click on "Show spare parts for" to access the complete catalogue for this loader model

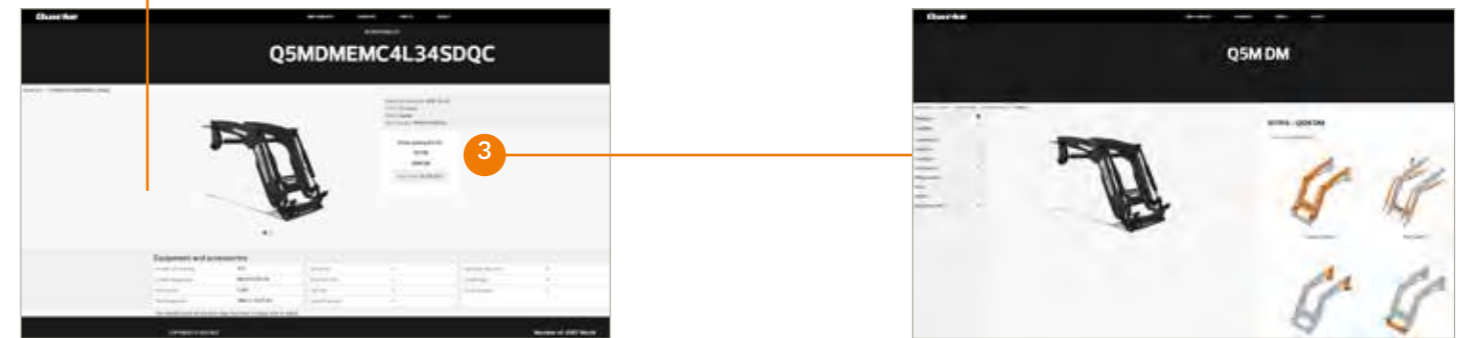

Spare parts standard navigation

Catalogue is composed of menu and sub-menus represented by icons easy to understand. Simply click on where you would like to go, and you will find what you are looking for.

Example of loader part search:

Select

1. Loader section
2. Loader Brand
3. Loader range
4. Loader model
5. Parts category
6. Sub Parts category
7. Item found!



Filtering function

A filter function on the bottom left of the webpage appears when a product come in different design releases depending on year of production.

Drag the bar to display the products manufactured within your selected period of time.

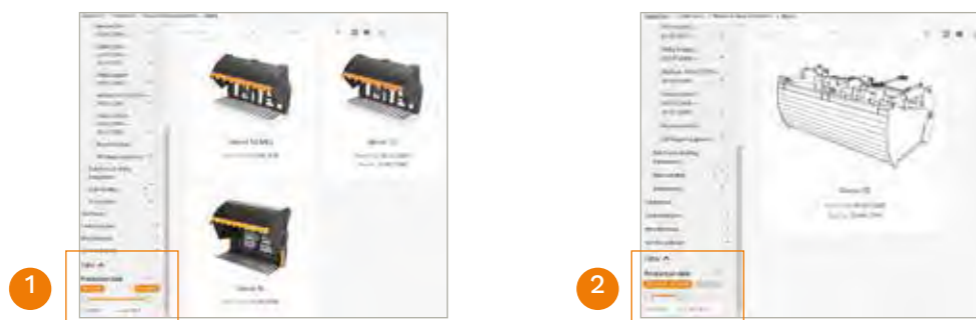

Search by QCS control system item number:

1. Type in hydraulic kit number in the searching bar (see page 2 for machine sign identification)
2. Click on the result to see main kit components
3. Click on the desired section to access the spare parts list

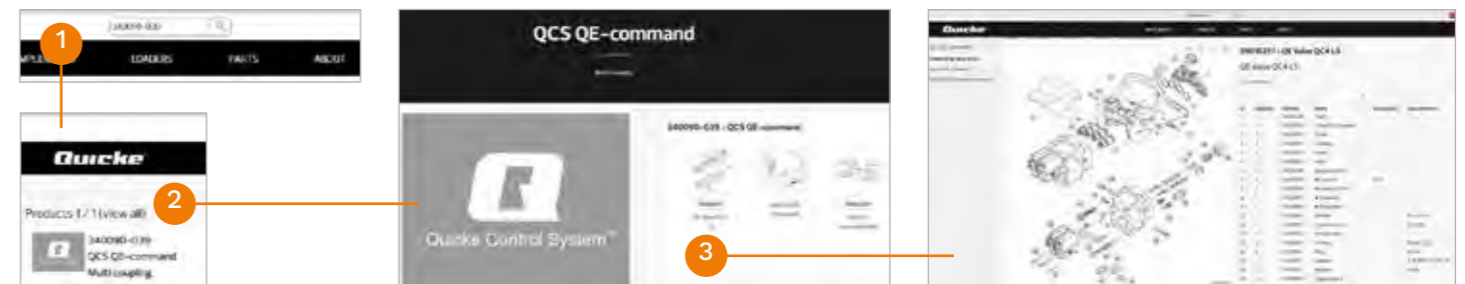

Spare parts for the control system can also be found in the Mounting Instructions included in the kit delivered to our dealers or in the Media Archive used by Ålö and our importers. Contact the Quicke support or your Quicke or Trima importer for support.

Spare parts to the subframes could be found in the Mounting Instruction included in the kit delivered to our dealers or in the Media Archived used by Ålö and our importers. Contact the Quicke support or your Quicke or Trima importer for support.



For Loaders produced from 2005.
Q25 to Q75, Q26 to Q88, Q3 to Q8M

Available on the iPhone **App Store** ANDROID APP ON **Google play**

THE FUTURE IS HERE IT'S CALLED Q-COMPANION®

Quicke introduces a digital platform into the world of handling machines: Q-companion. An all-in-one digital solution for effective and safe handling operation. Use Q-companion to load the right amount of material, avoid over-loading of trailers and save unnecessary trips to the feed pit.

THE MAIN FUNCTIONS

Position monitoring. Once you've calibrated your implements, there's no longer any need to go out and adjust the angle indicator rod on the loader, use Q-companion instead! The implement position is displayed in relation to the ground for both height and angle. Functions that will increase your precision and safety.

Load weighing. Q-companion weighs the load during the lift with fantastic accuracy and provides guidance that helps you lift correctly for best results. Let Q-companion keep track of your work for you.

Maintenance reminder. Two individual maintenance indicators will tell you when it's time to lubricate and time for hardware torque checks. The time between maintenance is based on actual loader usage, not tractor usage. Loader maintenance is often forgotten and can result in down-time and repairs. Follow the maintenance schedule for trouble-free operation for years to come!

Weigh your bales and count them automatically. Know how much material is stored and where on the farm it is stored, thanks to the app. A clever maintenance reminder is also included to aid in taking good care of your machine.

App and Cloud Service. Q-companion includes a free-of-charge smartphone app for iOS and Android, just search for Q-companion in the app stores. Using Bluetooth® technology, you can easily export weighing results from the Q-companion display to the cloud service and later access it on your computer or tablet.

In the forefront. Farming is changing, and with Q-companion you'll be in the forefront. By integrating state of the art sensor technology on to our loader's, the new Q-series is prepared for the future. Your efficiency is our guideline, and we guarantee you'll work smarter knowing your implement position, loaded weight and maintenance status just by looking at the colour display.

Item no: 59042200 fits the Quicke and Trima Q-series from year 2020 with QCS control systems

Item no: 60029447 fits the Quicke and Trima Q-series from 2017 – 2020 (requires SoftDrive).

Item no: 60040200 fits the Quicke Dimension and Trima Plus series from 2005 – 2017.

Item no: 60071797 Generic DIY kit to install on other loaders, telehandlers and wheel loaders etc.

1+1=3

COMBINE Q-COMPANION WITH Q^E-COMMAND CONTROL SYSTEM TO ACCESS TO MANY MORE FEATURES AND FUNCTIONALITIES!

QMotion Automate your repetitive tasks

QRange Limits the working range to improve efficiency and safety

QEnds End position damping for optimum comfort & efficiency

QShake Evenly spread material without implement drift and lost material



PARTS HIGHLIGHTS



LoaderLight™

LoaderLight always gives you a beam of light at the implement level and follow the movement of the loader. Contains two 10 W heavy duty LED lamps (2x1052 lumen), 12 V and 2x0,75 Ampere, IP68. Compatible with all other options except 4th function and ESV valve.

Item no 5048217 fits the Quicke Dimension and Trima Plus series from year 2005.

Item no 60024312 fits the Quicke and Trima Q-series from year 2017.



SoftDrive™ (load damping)

With SoftDrive (load damping) you can drive the tractor faster with better control. It also protects your tractor by reducing constraints. Provides a more comfortable ride. SoftDrive is available for all loader range.

Item no 5034241 fits the Quicke and Trima Versa-X and 200 series

For other loader models contact your sales representative for correct kit number or have a look at the section "Kits for loaders produced before 2017" on page 30.



Selecto Fix™

With Selecto Fix, you get an ergonomic and effective tool that saves valuable time. If your front loader is equipped with 3rd or 4th function, Selecto Fix provides simple, problem-free connection of the implement hydraulics, even when pressurised.

Item no 10550379 fits the Quicke and Trima produced between 2002 – 2007 (– s/n 7234199)

Item no 10550380 fits the Quicke Dimension and Trima Plus series from 2007 (s/n 7234199 –)

Item no 5221553 fits the Quicke and Trima Versa-X series

Item no 10550180 is used at the implement side in combination all above

For correct part number for the Q-series loader, contact your local sales representative.



QCS PARTS

In 2020, Quicke launched a new serie of robust controls for smart farming – our new Quicke Control System (QCS). In the below section, we display a selection of new spare parts for QCS. Could not find what you are looking for? Visit our online parts catalogue to show the complete range of spare parts available for this control system.

Q^M-COMMAND



Joystick handle

Item No	59030100	59030140	59030110	59030120	59030130
Note	No switches	3rd service	3rd service Softdrive	3rd service Softdrive Q-Lock	3rd service Softdrive Q-Lock 4th Service AUX Buttons

	Item No	Description	Note
	59033001	Gaiter	For straight lever
	59033016	Strain relief	To position and maintain electric cable in place
	59033020	Lever complete	Straight lever
	59033010	Housing complete	Contains A and B
	59033012	Pivot ball	A
	59033015	Screw M8 x 25	B
	59030499	Attachment kit	To connect control cables to hydraulic valve

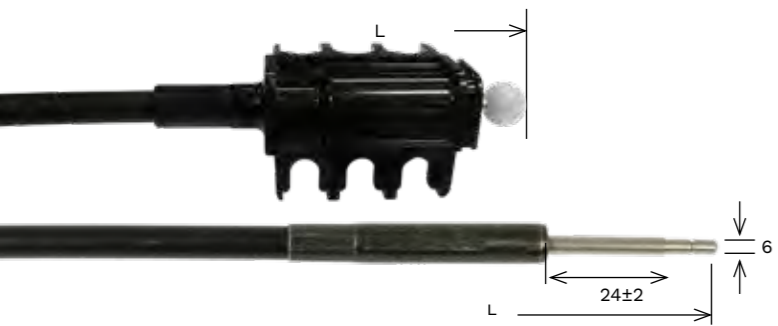

Control cables

Our Control cables have significant less internal gap compared to similar cables even in the longest and most complex cable routings. The design also make them smooth to push/pull. This gives outstanding control when needed in precision work.

Item No	Description	Length
59030310	Control cable	L = 1000 mm
59030311	Control cable	L = 1100 mm
59030312	Control cable	L = 1100 mm
59030314	Control cable	L = 1400 mm
59030316	Control cable	L = 1600 mm
59030318	Control cable	L = 1800 mm
59030320	Control cable	L = 2000 mm
59030322	Control cable	L = 2200 mm
59030324	Control cable	L = 2400 mm
59030326	Control cable	L = 2600 mm
59030328	Control cable	L = 2800 mm
59030330	Control cable	L = 3000 mm
59030332	Control cable	L = 3200 mm

Q^E-COMMAND

The new electronic control system which features great hand ergonomics and possibility to operate all loader functions as standard.



Joystick 59030500



Thumbstick kit 4501144



M12 L = 150 59030502



M12 L = 240 59030503



M12 L = 290 59030504

COUPLINGS AND MULTICOUPLINGS

Item No	Description	Note
59021040	Quick coupling SF4 / SF6	For control system with single couplings – Valve side
59021044	Seal kit	Delivered in bag of 10 pcs
59021046	Quick coupling QC4 / QC6 / QC6c	For control system with multicouplings – Loader side
59021047	Seal kit	Delivered in bag of 10 pcs
59021041	Quick coupling QC4 / QC6 / QC6c	For control system with multicouplings – Valve side
59018100	Seal kit	For Q ^M -command valves 4 hydraulic ports
59018200	Seal kit	For Q ^E -command valves 4 hydraulic ports
59018300	Seal kit	For Live 3 valves – 6 hydraulic ports Q ^E -command & Q ^M -command
59021030	Rubber coupling plug	For single couplings devices – Valve side – Black colour
59021031	Rubber electric connector plug	For multicouplings devices – Valve side

Single couplings 4 ports **SF4**



Multi couplings 4 ports **QC4**



Multi couplings 6 ports compact **QC6c**



Multi couplings 6 ports **QC6**



JOYSTICK PARTS

For access to the complete range visit our Spare part viewer at our homepages.
www.quicke.nu or www.trima.nu



ERGODRIVE

Loader Control System™

	5020346	5020938	5020961	5021103	5021037	5021048	5021038
	3 rd + 4 th (1992 – 2007)	3 rd + Softdrive (2007 – 2010)	3 rd + 4 th Softdrive (2007 – 2010)	200-Series (2011 –)	3 rd + Softdrive (2010 –)	3 rd + 4 th + Softdrive R (2010 –)	3 rd + 4 th + Softdrive L (2010 –)
M12 5020373	•						
M18x1,5 4500352		•	•	•	•	•	•
$\varnothing 14$ 5020374	•						
$\varnothing 15$ 4500353		•	•	•	•	•	•
5020382	•						
4500343		•	•	•			
5021044					•	•	•
5024366	•	•	•	•	•	•	•
4500355		•	•		•	•	•
M12 5020387	•						

ELECTRODRIVE QS

4501087
 Replaces Easydrive 60006439 and Electrodrive 60006437.



Part No	Description	Length	Item No
5103100 (<-2015)	• A		
60006414 (2015->)	• B		
4501267			
4501268			
M10 L = 150			5103058
M10 L = 300			5103057
M10 L = 350			5103083

CONTROL CABLES

Our Control cables have significant less internal gap compared to similar cables even in the longest and most complex cable routings. The design also make them smooth to push/pull. This gives outstanding control when needed in precision work.

Quicke | TRIMA

Loader Control System™



Quicke | TRIMA



Quicke • Trima •

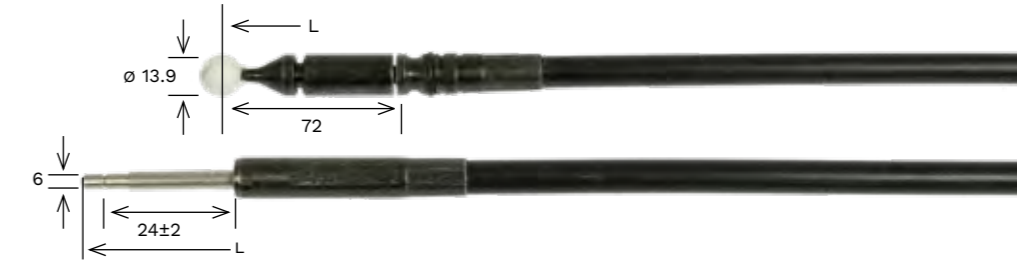

Item No	Description	Length	QUICKE	TRIMA	Year
5021026	Cable	L = 1200 mm	•	•	2010 –
5021027	Cable	L = 1400 mm	•	•	2010 –
5021028	Cable	L = 1600 mm	•	•	2010 –
5021029	Cable	L = 1800 mm	•	•	2010 –
5021030	Cable	L = 2000 mm	•	•	2010 –
5021031	Cable	L = 2200 mm	•	•	2010 –
5021032	Cable	L = 2400 mm	•	•	2010 –
5021033	Cable	L = 2600 mm	•	•	2010 –
5021034	Cable	L = 2800 mm	•	•	2010 –
5021035	Cable	L = 3000 mm	•	•	2010 –
5021036	Cable	L = 3200 mm	•	•	2010 –



Item No	Description	Length	QUICKE	TRIMA	Year
5021130	Cable	L = 800 mm	•	•	1992 –
5021132	Cable	L = 1000 mm	•	•	1992 –
5020940	Cable	L = 1200 mm (5020351)	•	•	1992 –
5020941	Cable	L = 1400 mm (5020352)	•	•	1992 –
5020942	Cable	L = 1600 mm (5020353)	•	•	1992 –
5020943	Cable	L = 1800 mm (5020354)	•	•	1992 –
5020944	Cable	L = 2000 mm (5020355)	•	•	1992 –
5020945	Cable	L = 2200 mm (5020356)	•	•	1992 –
5020946	Cable	L = 2400 mm (5020357)	•	•	1992 –
5020947	Cable	L = 2600 mm (5020358)	•	•	1992 –
5020948	Cable	L = 2800 mm (5020359)	•	•	1992 –
5020949	Cable	L = 3000 mm (5020360)	•	•	1992 –
5020950	Cable	L = 3200 mm (5020361)	•	•	1992 –



Item No	Description	Length	QUICKE	TRIMA	Year
20729820	Cable	L = 1200 mm		●	1980 – 2000
20729821	Cable	L = 1400 mm		●	1980 – 2000
20729822	Cable	L = 1600 mm		●	1980 – 2000
20729823	Cable	L = 1800 mm		●	1980 – 2000
20729824	Cable	L = 2000 mm		●	1980 – 2000
20729825	Cable	L = 2200 mm		●	1980 – 2000
20729826	Cable	L = 2400 mm		●	1980 – 2000
20729827	Cable	L = 2600 mm		●	1980 – 2000
20729828	Cable	L = 2800 mm		●	1980 – 2000

TRIMA



Quicke



Item No	Description	Length	QUICKE	TRIMA	Year
5020302	Cable	L = 800 mm	●		– 1980
5020304	Cable	L = 1200 mm	●		– 1980



Item No	Description	Length	QUICKE	TRIMA	Year
5020312	Cable	L = 500 mm	●		1980 – 1992
5020316	Cable	L = 700 mm	●		1980 – 1992
5020320	Cable	L = 1000 mm	●		1980 – 1992
5020313	Cable	L = 1200 mm	●		1980 – 1992
5020311	Cable	L = 1600 mm	●		1980 – 1992
5020317	Cable	L = 2000 mm	●		1980 – 1992
5020314	Cable	L = 2400 mm	●		1980 – 1992

Quicke

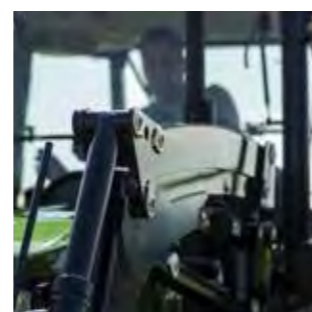

TRIMA



Item No	Description	Length	QUICKE	TRIMA	Year
20729802	Cable	L = 600 mm		●	– 1980
20729801	Cable	L = 700 mm		●	– 1980
20729800	Cable	L = 800 mm		●	– 1980
20729804	Cable	L = 1000 mm		●	– 1980
20729812	Cable	L = 1100 mm		●	– 1980
20729805	Cable	L = 1200 mm		●	– 1980
20729813	Cable	L = 1400 mm		●	– 1980
20729807	Cable	L = 1600 mm		●	– 1980
20729808	Cable	L = 1800 mm		●	– 1980
20729809	Cable	L = 2000 mm		●	– 1980
20729811	Cable	L = 2400 mm		●	– 1980



Item No	Description	Length	QUICKE	TRIMA	Year
521087	Cable	L = 1500 mm	●		– 1980
521088	Cable	L = 2000 mm	●		– 1980

Quicke



PINS

Our unique pin locking reduce the gaps and keep the grease in place. Replace pins if they are damaged to avoid consequential damages at the loader or tractor!

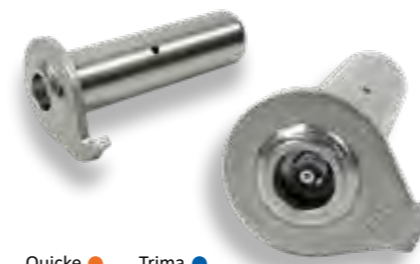

Quicke ● Trima ●

Quicke ● Trima ●

A LOADER PIVOT PINS QUICKE DIMENSION AND Q-SERIES

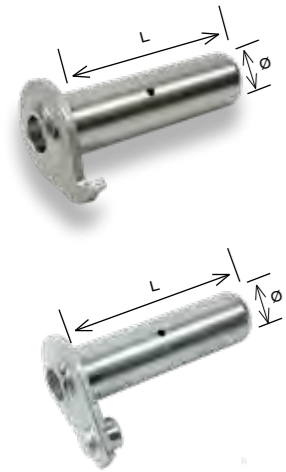

Item No	Description	ø D	L	Note
60018050	Pivot pin	30	84	Repl. 9020039
60018047	Pivot pin	30	96	Repl. 9020037
9020105	Pivot pin	30	113	Repl. 9020035
9020100	Pivot pin	30	122	Versa X, 200 Series
60018046	Pivot pin	30	127	Repl. 9020034
60018059	Pivot pin	35	84	Repl. 9020040
60018058	Pivot pin	35	96	Repl. 9020038
60018053	Pivot pin	35	127	100 Series
60018062	Pivot pin	40	127	Repl. 9020036
60019828	Pivot pin	40	147	Repl. 9020061
60003247	Pivot pin	35	127	Q-series with another rotation stop
60003248	Pivot pin	40	127	Q-series with another rotation stop

LOADER PIVOT PINS QUICKE 700 AND 900 SERIES

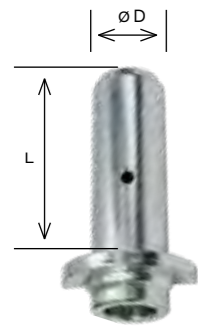

Item No	Description	ø D	L	Note
1116923	Pivot pin	30	84	
1116930	Pivot pin	30	96	Also repl. 1116921, 1116441
1116922	Pivot pin	30	110	
1116932	Pivot pin	30	119	Without greaser, without greasing hole
1116946	Pivot pin	30	122	
1116928	Pivot pin	30	131	
1116464	Pivot pin	35	92	
1116938	Pivot pin	35	96	
1116462	Pivot pin	35	101	Also repl. 1116936
1116943	Pivot pin	35	107	Also repl. 1116942
1116941	Pivot pin	35	119	Also repl. 1116940
1116463	Pivot pin	35	123	
1116935	Pivot pin	35	132	
1116933	Pivot pin	35	133	Also repl. 1116939
1116937	Pivot pin	35	144	
1116934	Pivot pin	35	166	
1116481	Pivot pin	40	101	
1116945	Pivot pin	40	107	
1116944	Pivot pin	40	118	
1116927	Pivot pin	40	121	
1116926	Pivot pin	40	138	

LOADER PIVOT PINS OLD TRIMA 2.XX, 3.XX, 4.XX, 5.XX, 6.XX, 7.XX SERIES

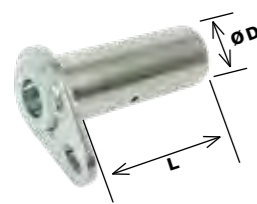

Item No	Description	ø D	L
20525072	Pivot pin	35	83
20525076	Pivot pin	35	95
20525080	Pivot pin	35	118
20525390	Pivot pin	35	103



B IMPLEMENT PIVOT PINS

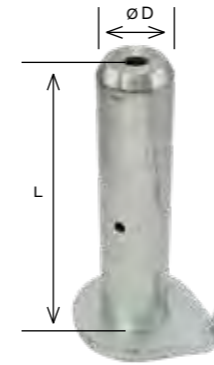

Item No	Description	ø D	L	Note
60018050	Pivot pin	30	84	Topgrip (replaces 9020039)
9020043	Pivot pin	30	105	Maxi Grapple
9020110	Pivot pin	30	105	Topgrip, Silograb S+, Multibenne S+
9020048	Pivot pin	30	125	Multibenne, Silograb
60018046	Pivot pin	30	127	Topgrip (replaces 9020034)
9020046	Pivot pin	30	129	Maxi Grapple
60019853	Pivot pin	30	141	Silograb S+, Multibenne S+
9020047	Pivot pin	30	151	Multibenne, Silograb, Maxi Grapple
9020073	Pivot pin	35	106	Silograb XL
9020107	Pivot pin	35	116	Powergrab, Silocut SE
60000355	Pivot pin	35	147	Silograb XL
9020063	Pivot pin	35	179	Powergrab, Silocut SE
9020093	Pivot pin	35	188	Silocut SE
60019828	Pivot pin	40	147	Powergrab XL, Silograb XL
9020126	Pivot pin	40	171	Silocut SG, M+
9020124	Pivot pin	40	190	Silocut SG, M+
60016543	Pivot pin	40	225	Powergrab XL
60030256	Pivot pin	40	229	Silocut XL

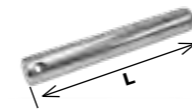

Item No	Description	ø D	L	Note
1116923	Pivot pin	30	84	Quadrogrip
11260558	Pivot pin	30	84	Quadrogrip
11260561	Pivot pin	30	129	Quadrogrip
1116806	Pivot pin	30	175	Unigrip
1116485	Pivot pin	40	175	Unigrip
1116435	Pivot pin	30	118	Flexibal
1116307	Pivot pin	30	211	Flexibal
60016512	Pivot pin	40	272	Powergrab XL, Silograb XL
60016513	Pivot pin	50	150	Powergrab XL, Silograb XL
1116656	Pivot pin	30	107	Quadrogrip
60032873	Pivot pin	35	193	Flexigrip
60053050	Pivot pin	25	100	Silograb S+, Multibenne S+
60051551	Pivot pin	25	117	Silograb S+, Multibenne S+
60051537	Pivot pin	25	156	Silograb S+, Multibenne S+
9020128	Pivot pin	50	96	Silocut SG, M+
11262660	Pivot pin	50	205	Silocut SG, M+
60027947	Pivot pin	60	265	Silocut XL

Note! When replacing a Pivot pin also replace these items to ensure optimal function!

Item No	Description	Item No	Description
5215121-1	Greaser cover black	5215131	Locking cover
60008692	Greaser cover	5050608 (Repl. 5004917)	Screw
60107382	Greaser cover		

Item No	Description
The 3 below items are replaced by combination of 5215131 & 5050608.	
5022089	Rubber ring
142893	Locking washer
5002076	Locking screw

BUSHINGS

To avoid abnormally wear it is important that bushings interface with the pin. These bushings will ensure the best function together with our galvanised Pivot pins.

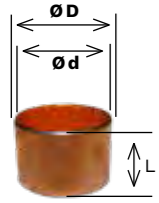

Item No	Description	Ø D	Ø d	L	Note
5018513	Bushing	44	40	20	Used at frontloaders and implements
5018514	Bushing	39	35	20	Used at frontloaders and implements
5018515	Bushing	34	30	20	Used at frontloaders and implements
5018517	Bushing	39	35	30	Used at frontloaders and implements
5018904	Bushing	44	40	30	Used at frontloaders and implements
60004007	Bushing	50	45	30	Used at frontloaders and implements
5018909	Bushing	55	45	40	Used on Silocut implements

LOCKING PINS FOR TOOL CARRIER

Tool carrier locking pins ensures correct and safe position of implement attached on the loader. Located at the bottom part of the loader, they are often in contact with dirt, sand, ground, silage and water. Check them regularly to prevent any damage.

Locking pins are different depending on tool carrier type fitted on loader. Here below are the available tool carrier types according to loader range.



Quicke Dimension | Trima-series Plus (2005 – 2017)

Euro	Euro/Typ 3	Euro/SMS	Euro/MX
Euro/FX	Valtra (Small BM)	Euro/HD	Big BM

Q-series (from 2017)

Euro	Euro/SMS	Euro/Typ 3	Euro/MXw
Euro/FX	Valtra (Small BM)	Big BM	

Series 200 (2011 – 2015) | Versa X (2013 – 2017) | X-series (from 2017)

Euro	Euro/SMS
------	----------

	Item No	Description	Ø D	L total	Type	Quicke Dimension, Trima Plus Series	Q-series	Versa X, 200 Series, X-series
	5219044	Locking pin	20	154	(8) Euro	●		
	5219125	Locking pin	20	215	(8+5) Euro/SMS	●		
	5219330	Locking pin	20	226	(8+3) Euro/Type 3	●	●	
	5219075	Locking pin	50	315	(9) Big BM	●	●	
	5219230	Locking pin	30	295	(6) Valtra L	●	●	
	5219231	Locking pin	30	295	(6) Valtra R	●	●	
	5220381	Locking pin	28	213	(8+2) Euro/MX	●	●	
	5220658	Locking pin	20	252	(8+4) Euro/FX	●	●	
	5220564	Locking pin	35	152	(8+7) Euro/Älö HD	●		
	5221594-*	Locking pin	N/A	N/A	(8) Euro			●
	5221443-*	Locking pin	N/A	N/A	(8+5) Euro/SMS			●
	4501175	Locking pin	N/A	N/A	(8+5) Euro/SMS		Q8M	
	4501177	Locking pin	N/A	N/A	(8) Euro		Q8M	
	4501176	Locking pin	N/A	N/A	(8+5) Euro/SMS		●	
	4501178	Locking pin	N/A	N/A	(8) Euro		●	
	4501166	Locking pin	N/A	N/A	(8+5) Euro/SMS		Q8M	
	4501169	Locking pin	N/A	N/A	(8) Euro		Q8M	
	4501164	Locking pin	N/A	N/A	(8+5) Euro/SMS		●	
	4501171	Locking pin	N/A	N/A	(8) Euro		●	

*Suffixe 1 is black, 7 is grey. Other colors are optional.

SERVICE & MAINTENANCE

Pro-active maintenance like replacing bushings will reduce gaps that create noise and complicates precision work. It also protect the pins and in the long term extend the loader lifetime.



BUSHING AND PIN KITS QUICKE DIMENSION AND TRIMA PLUS SERIES

Item No	Description	Fits to: QUICKE	TRIMA
5018911	Bushing kit	Q20 – Q50, Q21 – Q51	+1.0 – +4.0, T+1.1 – +4.1
5018912	Bushing kit	Q60, Q61	+5.0, +5.1
5018913	Bushing kit	Q25 – Q55, Q26 – Q58	+1,0P – +4.0P, +1,1P – +4.3P
5018914	Bushing kit	Q65 – Q85, Q66 – Q98	+5,0P – +8.0P, +5,1P – +8.3P
60021062	Pin kit	Q20 – Q50, Q21 – Q51	+1.0 – +4.0, T+1.1 – +4.1
60021064	Pin kit	Q60, Q61	+5.0, +5.1
60021065	Pin kit	Q25 – Q55, Q26 – Q58	+1,0P – +4.0P, +1,1P – +4.3P
60021066	Pin kit	Q65, Q66 – Q68	+5.0P, +5.1P – +5.3P
60022287	Pin kit	Q75 – Q85, Q76 – Q98	+6.0P – +8.0P, +6.1P – +8.3P



BUSHING AND PIN KITS QUICKE 300-, 400-, 500-, 600-, 700- AND 900-SERIES

Item No	Description	Fits to: QUICKE
4500012	Bushing kit	Q710 – Q760US, Q435 – Q445US*, Q310 – Q320*, Q340 – Q350*
4500013	Bushing kit	Q770UM, Q770US
4500015	Bushing kit	Q910 – Q950US, Q950UM, Q1050DM, Q510 – Q560US, Q560UM, Q580US, Q580UM, Q610 – Q670 US, 670UM, Q415 – Q450US*
4500016	Bushing kit	Q675US, Q675UM, Q960 – Q970US, Q960 – Q970UM, 1060DM, 1070DM
4500017	Bushing kit	Q690 – Q695US, Q690 – Q695UM, Q980 – Q985US, Q980 – Q985UM, 1080DM, 1085DM
4500018	Bushing kit	Q990
4500050	Bushing kit	Q710 – Q760US, Q435 – Q445US*, Q310 – Q320*, Q340 – Q350*
4500051	Bushing & pin kit	Q960UM, Q970UM
4500052	Bushing & pin kit	Q910 – Q950US, Q950UM, Q610 – Q670US, Q510 – Q560US, Q560UM
4500053	Bushing & pin kit	Q980UM, Q985UM

* Note: depending on loader model, some kits can be provided with extra items not used on that specific loader.

WEO MAINTENANCE KITS

These fittings could be used to repair a hose with WEO fittings.

Item No	Description	Item No	Description
4500379	WEO 1/4"-1/4" Hose A	5028058	Assembly stop 1/4" (10 pcs) E
4500380	WEO 3/8"-3/8" Hose A	5028009	Assembly stop 3/8" (10 pcs) E
4500381	WEO 1/2"-1/2" Hose A	5028010	Assembly stop 1/2" (10 pcs) E
4500382	WEO 1/2"-3/8" Hose A	5028059	Release ring 1/4" (10 pcs) C
4500386	Seal kit 1/4" (10 pcs) B	5028011	Release ring 3/8" (10 pcs) C
4500387	Seal kit 3/8" (10 pcs) B	5028012	Release ring 1/2" (10 pcs) C
4500388	Seal kit 1/2" (10 pcs) B		
4500383	O'ring kit 1/4" (10 pcs) D		
4500384	O'ring kit 3/8" (10 pcs) D		
4500385	O'ring kit 1/2" (10 pcs) D		

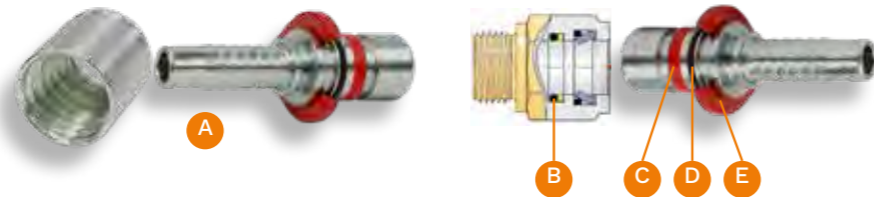

Fits to Quicke Dimension and Trima Plus Series

COMPLETE SERVICE KIT FOR QUICKE DIMENSION AND TRIMA PLUS 2003 TO 2017

The service kit contains complete pin- and bushing kits for renovation of all the pivot points on the front loader. With the kit all parts for renovating the load damping system – SoftDrive – will follow. To be proactive and change these parts on-time will prevent from further damage on other critical components and take away the play in the joints.



Item No	Description	Fits to: QUICKE	TRIMA
4501078	Service kit	Q25 – Q45	1.0P – 3.0P
4501079	Service kit	Q55	4.0P
4501080	Service kit	Q65	5.0P
4501081	Service kit	Q75 – Q85	6.0P – 7.0P
4501082	Service kit	Q26 – Q49	1.1P – 3.4P
4501083	Service kit	Q56 – Q58	4.1P – 4.3P
4501084	Service kit	Q66 – Q68	5.1P – 5.3P
4501085	Service kit	Q76 – Q88	6.1P – 7.3P

BUSHING- AND PIN KITS FOR Q-SERIES

Item No	Description	Fits to: QUICKE	TRIMA
60039591	Bushing kit	Q3 – Q5	–
60039595	Bushing kit	Q6	–
60039629	Bushing kit	Q35 – Q5L	Q35 – Q5L
60039645	Bushing kit	Q65 – Q8M	Q65 – Q8M
60039680	Pin kit	Q3 – Q5	–
60039681	Pin kit	Q6	–
60039647	Pin kit	Q35 – Q5L	Q35 – Q5L
60039672	Pin kit	Q65 – Q8M	Q65 – Q8M



BUSHING- AND PIN KITS FOR VERSA X AND X-SERIES

Item No	Description	Fits to: QUICKE	TRIMA
60039500	Bushing & pin kit	X3 – X5, X31 – X51	X31 – X51
60039507	Bushing & pin kit	X35 – X55, X36 – X56	X36 – X56



GREASER COVER KIT FOR QUICKE DIMENSION, TRIMA PLUS, VERSA X, X-SERIES AND Q-SERIES

Item No	Description	Fits to: QUICKE	TRIMA
60028768	Greaser cover kit	Q20 – Q40, Q50, Q60, Q21 – Q41, Q51, Q61, X21 – X51, X1 – X5	+1.0 – +5.0, +1.1 – +5.1, X21 – X51
60028770	Greaser cover kit	Q25- Q85, Q26 – Q76, Q38 – Q98, Q39-Q49, X26 – X56, X1S – X5S	+1.0P – +5.0P, +1.1P – +8.3P, X16 – X56
60028771	Greaser cover kit	Q3 – Q5, Q35 – Q8M	Q35 – Q8M



LOADER SERVICE SUITCASES

Machines waiting for parts aren't efficient. That's why we invented the Loader Service Suitcase. A service solution, stackable, mobile, that is both flexible and scalable. Think of it as a service

technicians first aid kit. Stocked with a large selection of main parts needed for fast repairs or on-site maintenance.

Item No	Description	Specification
60045026	Front loader parts	Valves, spools, sealings, WEO couplings, sensors, pin covers, and pin bolts.
60045023	Q-series update	New specific parts for Q-series loader and room for parts of your choice.
60045027	Ergodrive LCS	A selection of parts dedicated to the LCS mechanical control system: spools, hand lever, switches, and seal kits.
60045028	Hydraulic couplings	Fitted on loaders; MC4 lever kit, safety buttons, seal kits.
60045030	Electrodrive QS	Main parts needed to service Electrodrive and Easydrive LCS control systems. Items such as joystick, ECU, valves, and seal kits.
60045034	Q-companion	Display, ECU, sensors-parts that need to be fully functional to perform weighing operations without any interruptions.
60045035	Electrics	Connectors, pins, switch box, and relay box. All the connectors you need on a loader gathered in one single suitcase.
60045036	Ergodrive & CDC	A selection of items to service first generation of Ergodrive and Electrodrive CDC control systems: ECU, joystick, hand lever.
60045037	Implements	Items such as implement hydraulic couplings, U bolts, hose holders, stop pins.
60045038	Trolley	The essential option to support service technician. Almost no effort needed to move the service suitcase around.

QUICKE SERVICE TOOL

Quicke service tool is a dedicated tool for QCS and Q-companion driver support systems. It helps technicians with service and repair activities such as:

- Software updates incl feature additions
- Fault checking and fault analysis
- Configuration of replaced actuators and much more

The Quicke service tool is provided within a robust suitcase for safe storage and can be delivered with additional parts for better service level (see below alternatives).



Quicke Service Tool PN: 60061637



NEW QCS SERVICE SUITCASES

A new range of service suitcases allowing service and maintenance on new QCS Control systems.

Item No	Description	Specification
60061638	Q ^M -command	A selection of parts dedicated to the QCS mechanical control system: spools, hand lever, switches, and seal kits
60061639	QCS Hydraulic couplings	Fitted on QCS new control systems; couplings, safety buttons, seal kits, connector holders etc.
60064310	Q ^E -command level 1	Main electronic parts to service Q ^E -command control systems. items such as joystick, actuator, Quicke service tool etc.
60064313	Q ^E -command level 2	Electric & hydraulic parts to service Q ^E -command control system. Perfect add on to Q ^E -command level 1 suitcase
60061636	Q ^E -command both levels	All you need to service Q ^E -command control systems. Composed by level 1 & level 2 suitcases at preferred price



Closed service suitcase



Trolley



Hydraulic couplings suitcase PN: 60045028



Q^E-command level 1 with Quicke service tool included



Q^E-command Level 2



QCS hydraulic couplings



Q^M-command



SEALING KITS TO CYLINDERS

1. To locate the correct sealing kit to your cylinder, go to www.parts.quicke.nu and follow these steps.
2. Locate the article number of the cylinder. Article number could be find on the barrel of the cylinder.
3. Type in your cylinders article number in the search field.
4. Click on the box below "Spare Part drawings". The cylinder is shown in an exploded view with a connected parts list. Position number 8 show the sealing kit on this cylinder.



2

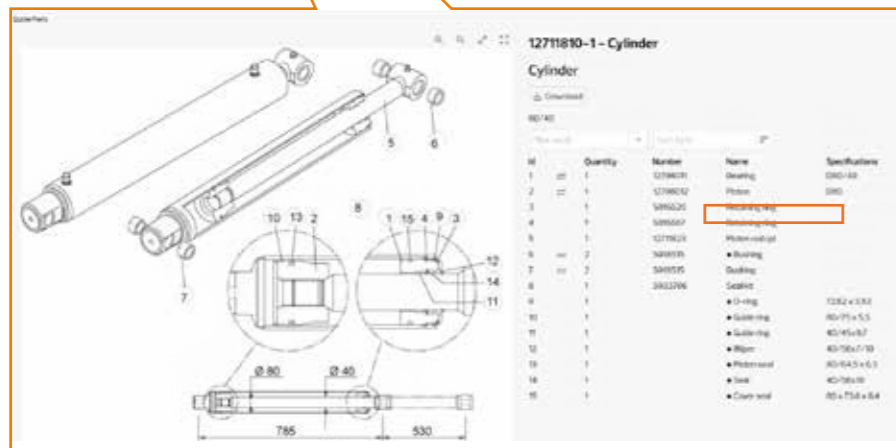

QUICK COUPLINGS

The couplings below are just a small selection. If you not find the Spare parts needed in the catalogue please visit our Spare part viewer at our homepages www.quicke.nu or www.trima.nu

Item No	Description	Note
5044949	Multicoupler MC-4	If you have individual quick couplings 5044976 and want to change to MC4 you must order the kit 5220530
5044968	Quick coupling MC4/MC2	Fits to 5044949
5044127	Quick coupling 1/2" (F)	ISO A 1/2"
5044130	Dust cap for 1/2" female coupling	Fits to 5044127
5044976	Quick coupling 3/8" flat face female	Flat face introduced with LCS
4500294 (repl. 5044956)	Quick coupling 3/8" flat face male	At loader valve (LCS)
4500293 (repl. 5040100)	Sealing kit (For one coupling)	Fits to 5044956 and or 4500294
9031324	Pluginadapter 3/8"	Compact valve
9031325	Pluginadapter 1/2"	Compact valve
5044131	Quick coupling R 1/2"	At loader valve
5044128	Quick coupling 1/2" (M)	At hose kits
5044915	Quick coupling 1/2" male	1/2" for 3rd and 4th
5044940	Quick coupling 3/8" male	3/8" for 3rd and 4th

BEARINGS

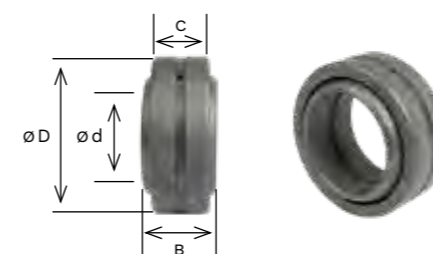

Bearings used at old Trima Series.

Item No	Description	ø D	ø d	B	C	Fits to
20732000	Bearing	62	40	28	22	Old Trima-series
20732001	Bearing	42	25	20	16	Old Trima-series
20732007	Bearing	62	35	35	22	Old Trima-series
20732116	Bearing	47	30	22	18	Old Trima-series
5018901	Bearing	55	35	25	20	Repl. 20732003

PLASTIC SPACER

Used at old Trima-series.

Item No	Description	DI	DY	D	L	Note
20525044	Spacer ring	47	55	60	18	Old Trima-series
20525045	Spacer ring	47	55	60	23	Old Trima-series

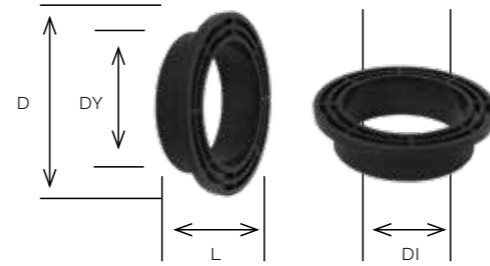

HOLDER KIT

Lever indicator holder kit. Four versions depending of cylinder barrel size.

Item No	Description	Ø (mm)
5215208	Level indicator holder kit	60, 70, 80, 85
5215209	Level indicator holder kit	70, 80, 90, 95
5215210	Level indicator holder kit	90, 100, 110
5221188	Level indicator holder kit	65, 75, 85, 90



GAS SPRING

Gas spring for tool carriers.



Item No	Description	L max	L min	N	Ø 1	Ø 2
5020621	Gas spring	485	285	300	12	12
5020624	Gas spring	485	285	200	12	12
5020626	Gas spring	270	173	200	11	11
5020627	Gas spring	385	260	200	11	11
5020628	Gas spring	282	185	200	10,2	10,2



PLASTIC COVERS

Plastic covers to the Quicke Dimension and Trima Plus-series.

Item No	Description	QUICKE	TRIMA
5215191	Cross beam cover, size 1	2x – 4x	1.x – 3.x
5215192	Cross beam cover, size 2	5x – 6x	4.x – 5.x
5215193	Cross beam cover, size 3	7x – 9x	6.x – 8.x
11135040	Quicke decal – Cross beam cover	●	
11135055	Trima decal – Cross beam cover		●
5220601	Hose clamp left	US, DS and DM	US, DS and DM
5220603	Hose clamp right	US, DS and DM	US, DS and DM
5215063	Hose clamp left	DL and DXL	DL and DXL
5215064	Hose clamp right	DL and DXL	DL and DXL
5215021	Valve cover	All models	All models
11135041	Quicke decal – Valve cover	●	
11135056	Trima decal – Valve cover		●
5215121-1	Greaser cover black	All models	All models



PLASTIC COVERS

Plastic covers to Quicke and Trima Q-series.

Item No	Description	QUICKE	TRIMA
60038006*	Cross tube side cover right	Q-series 3 – 5	Q-series 3 – 5
60038007*	Cross tube side cover left	Q-series 3 – 5	Q-series 3 – 5
60038008*	Cross tube side cover right	Q-series 6 – 8	Q-series 6 – 8
60038009*	Cross tube side cover left	Q-series 6 – 8	Q-series 6 – 8
60104335	Side cover right	DM	DM
60104343	Side cover left	DM	DM
60023103	Side cover right	DL	DL
60023102	Side cover left	DL	DL
60011240	Side cover right	DXL	DXL
60011241	Side cover left	DXL	DXL
60104341	Valve cover	All models	All models
60016662	Quicke decal – Valve cover	●	
60107928	Trima decal – Valve cover		●
60008692	Greaser cover A	All models	All models
60107382	Greaser cover B	All models	All models
60019418	Hose outlet cover kit, STD	All models	All models
60019419	Hose outlet cover kit, LT3D	All models	All models



* Explanation:
 60038006 replaces 60107456
 60038007 replaces 60107457
 60038008 replaces 60107458
 60038009 replaces 60107459

Quicke ● Trima ●



ELECTRIC CONNECTORS

Below you can find most the common used electric connectors on our loaders and control systems.

DEUTSCH CONNECTORS DT-SERIES

Item No	Description	Note	Example of use
60039945 60039944 60039948	Male connector pin (bag of 25 pcs) Female connector pin (bag of 25 pcs) Plastic plug (bag of 25 pcs)	DT Series DT Series DT Series	
5050394 5051124 5050400 60028156	Male receptacle 2 pins Male wedgelock 2 pins Female receptacle 2 pins Female wedgelock 2 pins	DT06-2S W2S DT04-2P W2P	Electric functions on loaders Q3 to Q8 ^M (from 2017) Connects loader valves and other electric functions to the main loader electric harness.
5050396 5051122 5050915 5050924	Male receptacle 4 pins Male wedgelock 4 pins Female receptacle 4 pins Female wedgelock 4 pins	DT06-4S W4S DT04-4P W4P	
5050397 5051121 5050403 5050923	Male receptacle 6 pins Male wedgelock 6 pins Female receptacle 6 pins Female wedgelock 6 pins	DT06-6S W6S DT04-6P W6P	Electric connection on Ergodrive LCS mechanical control system harness. Connects both sides of harness cabin side / external tractor side.
5050916 5050922 5050914 5050921	Male receptacle 8 pins Male wedgelock 8 pins Female receptacle 8 pins Female wedgelock 8 pins	DT06-8SA W8S DT04-8PA W8P	Electric connection between tractor & loader on LCS systems (from production 2011 to 2020)
4501198 5050918 5050925	Kit Male receptacle + Wedgelock 12 pins Female receptacle 12 pins Female wedgelock 12 pins	DT06-12SA CE10 + W12SA DT04-12PA W12P	Electric connection between tractor & loader on QCS systems (from production Nov 2020)

AMP & DIN CONNECTORS

Item No	Description	Note	Example of use
60039938 60039939 60039948	Female connector pin (bag of 10 pcs) Rubber plug (bag of 10 pcs) AMP Junior female connector 2 pins	AMP Jr Series AMP Jr Series AMP Jr Series	Electric functions on loaders Q20 to Q98 (2005 to 2017) Connects loader valves and other electric functions to the main loader electric harness.
5024376	Female connector 4 pins + LED	DIN43650	Electric functions (3rd & 4th) on Q700/ Q900 series Solenoid connector on Diverter valve

DEUTSCH CONNECTORS DTM SERIES

Item No	Description	Note	Example of use
60039946 60039947 60039949	Male connector pin (bag of 25 pcs) Female connector pin (bag of 25 pcs) Plastic plug (bag of 20 pcs)	DTM Series DTM Series DTM Series	
5051554 5051559 5051553 5051558	Male receptacle 4 pins Male wedgelock 4 pins Female receptacle 4 pins Female wedgelock 4 pins	DTM06-4S WM4S DTM04-4P WM4P	Q ^M -command lever harness where AUX functions buttons are connected
5051556 5051561 5051555 5051560	Male receptacle 6 pins Male wedgelock 6 pins Female receptacle 6 pins Female wedgelock 6 pins	DTM06-6S WM6S DTM04-6P WM6P	Q-companion connector on display in-cab harness
5051557 5051562	Male receptacle 12 pins Male wedgelock 12 pins	DTM06-12SA WM12S	Q-companion display connector on backside

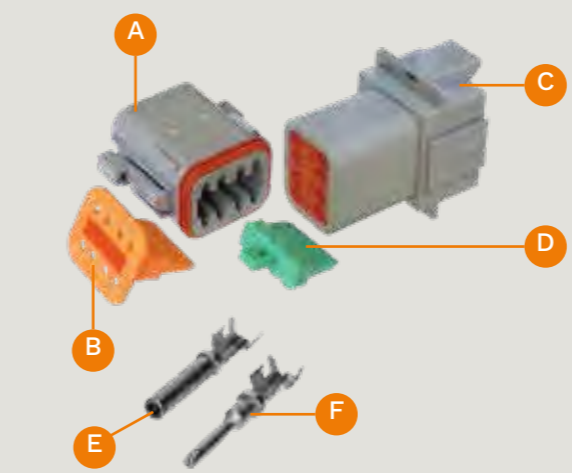

WHAT IS WHAT?

- A Male receptacle
- B Male wedgelock
- C Female receptacle
- D Female wedgelock
- E Male connector pin
- F Female connector pin

ELECTRIC CONNECTORS SERVICE SUITCASE

All main electric components used on Quicke loaders stacked in a robust suitcase. Sorted by component type and delivered with the list of all items part number provided for easy reorders.



Electric service suitcase PN 60045035

PARTS SHELF

Display key parts out in the shop. We support with the display unit and branding features. Contact your sales representative for more information.



PROTECT YOUR EQUIPMENT

ACCUMULATORS

With load damping you can drive the tractor faster without losing control. For optimal performance and comfort the accumulators must be replaced

when the pre-charge pressure has dropped due to normal Gas Permeation or damaged by other cause.

Item No	Description	Precharge setting (bar)	Capacity (litre)	Note
5033773	Accumulator 0,5 l, 22 bars, G1/2" F	22	0,5	Replaces 60044837
5034102	Accumulator 0,5 l, 15 bars, G1/2" F	15	0,5	Replaces 5033772
5045140	Accumulator 0,5 l, 20 bars, G1/2" F	20	0,5	
5045141	Accumulator 1,0 l, 20 bars, G1/2" F	20	1,0	
60065158	Accumulator 1,0 l, 22 bars, G1/2" F	22	1,0	
4501258	Accumulator 0,5 l, 22 bars, G1/2" M	20	0,5	Replaces 60011611

	5013853	Sealing Washer Gbr 1/2
	5215011*	Accumulator Bracket Size 1 (S)
	5215012*	Accumulator Bracket Size 2 (M)
	5215013*	Accumulator Bracket Size 3 (L)



**The plastic bracket have 3 different size depending of the diameter of the cross tube at the loader.

PAINT

Repair paint in different brand colours. Spray can and 1 l paint.



Colour	Item No	Suffix	Spray	Can	Colour	Item No	Suffix	Spray	Can	Colour	Item No	Suffix	Spray	Can
Grey texture*1	4500107 4500115	-7 -7	●	●	MF Red	4500110 4500120*6 4500462 4500461*7	-2 -2 -19 -19	●	●	AGCO/MF Grey*8	4500902	-18 -18	●	●
Ålö Black*2	4500314 4500315	-1 -1	●	●	Challenger Yellow	4500111 4500122	-4 -4	●	●	New Holland Blue	4500235 4500317	-11 -11	●	●
Black texture*3	4500895 4500893	-17 -17	●	●	McCormick Red	4500112 4500118	-6 -6	●	●	Case IH Red	4500236 4500318	-13 -13	●	●
Silver*4	4500204 4500203	-10 -10	●	●	Kubota Orange	4500113 4500119	-3 -3	●	●	John Deere Green	4500435 4500434	-12 -12	●	●
Ålö Terracotta	4500988 4500989	-27 -27	●	●	Fendt Green	4500114 4500121	-5 -5	●	●	Zetor Red	4500900 4500901	-25 -25	●	●
Ålö Ochra	4500990 4500991	-28 -28	●	●	AGCO Orange	4500234 4500316	-16 -16	●	●	Deutz Green	60005864 60006275	-15 -15	●	●
Orange*5	4500305 4500306	-22 -22	●	●						Quicke Noir/Grey Quicke Noir/Grey*9	5046006 5046105	-8 -8	●	●

*1 Note: QD series and Valtra | *2 Note: Trima subframes and Implements up till 2013 | *3 Note: Q-series and Implements as of 2013 | *4 Note: Silver P-rod | *5 Note: Cutting edge/Silcut knives as of 2017 | *6 Note: Replaced til 2009 s/n 7281677 | *7 Note: Used from 2009 s/n 7281677 | *8 Note: Subframes and Valves | *9 Note: 700/900-series

● 0.4 l Spray ● 1 l Can

KITS FOR LOADERS PRODUCED BEFORE 2017

3RD & 4TH SERVICE KITS

Item No	Description	Fits to loader widths	Fits to: QUICKE
5220450	3rd Service kit	DS & US (900 mm)	Q20 – Q56 +1.0 – +4.1P
5220451	3rd Service kit	DM & UM (1040 mm)	Q20 – Q78 +1.0 – +6.3P
5220452	3rd Service kit	DL (1200 mm)	Q85 – Q88 +7.0 – +7.3P
5220519	4th Service kit	DS & US (900 mm)	Q20 – Q56 +1.0 – +4.1P
5220518	4th Service kit	DM & UM (1040 mm)	Q20 – Q78 +1.0 – +6.3P
5220517	4th Service kit	DL (1200 mm)	Q85 – Q88 +7.0 – +7.3P



Kits adapted for Quicke & Trima loaders as above produced from 2005 to 2017

Item No	Description	Fits to: QUICKE
313403	3rd Service kit	Q230, Q330, Q430
313413	3rd Service kit	Q310 – Q340, Q415 – Q450, Q610 – Q690
10550218	3rd Service kit	Q675, Q695, Q710 – Q790, Q910 – Q990, Q1050 – Q1085
313404	4th Service kit	Q230, Q330, Q430
313414	4th Service kit	Q310 – Q340, Q415 – Q450, Q610 – Q690
313325	4th Service kit	Q675, Q695, Q710 – Q790, Q910 – Q990, Q1050 – Q1085

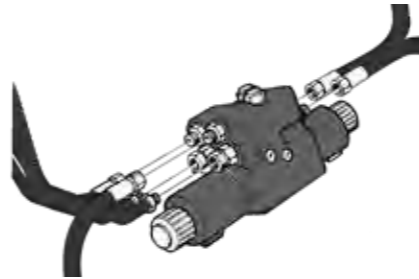

Item No	Description	Fits to: TRIMA
20430076	3rd Service kit	200, 300, 400 series from year 2002 600, 700 series
20430077	4th Service kit	300, 400 series from year 2002 600, 700 series



IMPLEMENT HYDRAULIC LOCKING KITS

Kits adapted for loaders produced from 2005 to 2017 with loader beam width 900 mm (US/DS type)

Item No	Description	Tool carrier	SN	Fits to: QUICKE	Fits to: TRIMA	Connection tractor <-> loader
5215260	Q-lock kit	Euro	<- 7332743	Q20 – Q56	+1.0 – +4.3P	Caravan (round – 7 pins)
5220690	Q-lock kit	Euro	7332744 ->			
5215261	Q-lock kit	Euro/SMS	<- 7332743			
5220696	Q-lock kit	Euro/SMS	7332744 ->	Q20 – Q56	+1.0 – +4.3P	Deutsch (Rectangular – 8 pins)
5220520	Q-lock kit	Euro	<- 7332743			
5220691	Q-lock kit	Euro	7332744 ->			
5220521	Q-lock kit	Euro/SMS	<- 7332743			
5220697	Q-lock kit	Euro/SMS	7332744 ->			



Kits adapted for loaders produced from 2005 to 2017 with loader beam width 1040 mm (DM type)

Item No	Description	Tool carrier	SN	Fits to: QUICKE	Fits to: TRIMA	Connection tractor <-> loader
5220692	Q-lock kit	Euro	7332744 ->	Q20 – Q78	+1.0 – +6.3P	Caravan (round – 7 pins)
5215263	Q-lock kit	Euro	<- 7332743			
5220698	Q-lock kit	Euro/SMS	7332744 ->			
5215264	Q-lock kit	Euro/SMS	<- 7332743	Q20 – Q78	+1.0 – +6.3P	Deutsch (Rectangular – 8 pins)
5220707	Q-lock kit	Euro/MX	7332744 ->			
5220693	Q-lock kit	Euro	7332744 ->			
5220522	Q-lock kit	Euro	<- 7332743			
5220699	Q-lock kit	Euro/SMS	7332744 ->			
5220523	Q-lock kit	Euro/SMS	<- 7332743			
5220708	Q-lock kit	Euro/MX	7332744 ->			



SOFTDRIVE KITS QUICKE DIMENSION AND TRIMA PLUS SERIES

Item No	Description	Fits to: SN	QUICKE	TRIMA	Production year	Connection loader <-> tractor	
5215233	Accumulator kit (on +side)	<- 7332743	Q20 – Q45	+1.0 – +3.0P	2005 – 2011	Caravan (round – 7 pins)	
5220661	Accumulator kit (on +side)	7332744 ->					
5215234	Accumulator kit (on +side)	<- 7332743	Q50 – Q65	+4.0 – +5.0P			
5220665	Accumulator kit (on +side)	7332744 ->					
5215235	Accumulator kit (on +side)	<- 7332743	Q75	+6.0P			
5220672	Accumulator kit (on +side)	7332744 ->	Q85	+7.0P			
5215235	Accumulator kit (on +side)	<- 7332743					
5220673	Accumulator kit (on +side)	7332744 ->	Q21 – Q49	+1.1 – +3.4P	2011 – 2017		
5220661	Accumulator kit (on +side)	7332744 ->					
5220665	Accumulator kit (on +side)	7332744 ->					
5220672	Accumulator kit (on +side)	7332744 ->	Q76, Q78	+6.1P, +6.3P			
5220673	Accumulator kit (on +side)	7332744 ->	Q88	+7.3P			
5220576	Accumulator kit (on -side)	To be added on every kit listed above				2005 – 2011	Deutsch (Rectangular – 8 pins)
5220538	Accumulator kit (for both sides)	<- 7332743	Q20 – Q45	+1.0 – +3.0P			
5220663	Accumulator kit (for both sides)	7332744 ->					
5220539	Accumulator kit (for both sides)	<- 7332743	Q50 – Q65	+4.0 – +5.0P			
5220667	Accumulator kit (for both sides)	7332744 ->					
5220540	Accumulator kit (for both sides)	<- 7332743	Q75	+6.0P			
5220674	Accumulator kit (for both sides)	7332744 ->	Q85	+7.0P			
5220540	Accumulator kit (for both sides)	<- 7332743					
5220675	Accumulator kit (for both sides)	7332744 ->	Q21 – Q49	+1.1 – +3.4P	2011 – 2017		
5220663	Accumulator kit (for both sides)	7332744 ->					
5220667	Accumulator kit (for both sides)	7332744 ->	Q51 – Q68	+4.1 – +5.3P			
5220674	Accumulator kit (for both sides)	7332744 ->	Q76, Q78	+6.1P, +6.3P			
5220675	Accumulator kit (for both sides)	7332744 ->	Q88	+7.3P			
60018952	Switch kit	To be added on kits listed above if needed					

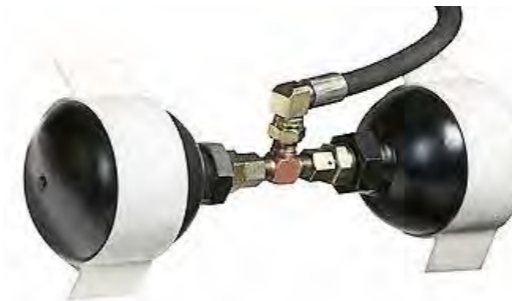

SUSPENSION KIT – LOADERS PRODUCED BEFORE 2005

Item No	Description	QUICKE
314010	Softdrive kit	Q310 – Q660
314070	Softdrive kit	Q465, Q675 – Q695
5048136	Softdrive kit	Q710 – Q750, Q910 – Q940, Q960, Q1060
5048137	Softdrive kit	Q760, Q770, Q950, Q970 – Q990, Q1050 – Q1085 (except Q1060)

Item No	Description	TRIMA
20375021	FLD800/Plusdrive	200, 300, 400 series up to year 2002
20375023	FLD800/Plusdrive	200, 300, 400 series from year 2002



TINES

With our selection of tines we guarantee that the tine will fit perfectly to the implement. All tines have the optimal strength and resistance against wear.

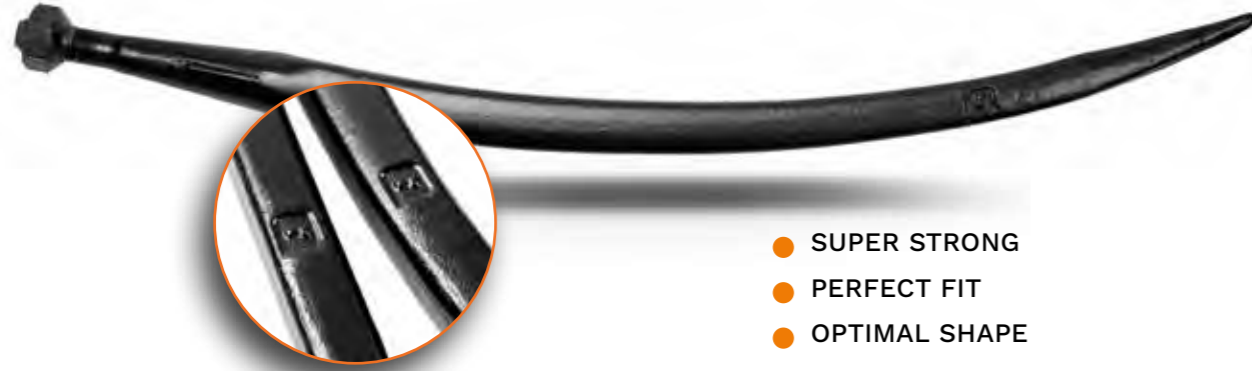

- SUPER STRONG
- PERFECT FIT
- OPTIMAL SHAPE

Tines	Item no	Description	Length	Thread	Fits to
	5068114-17 repl. 5068003-17	Tine conus 2, straight	820	M30 x 2	Bale Fork, Bale Fork Mk 1 / S+ / M / L / L+ / XL+, Silocut, Silocut SE / SG / MG
	5068120-17 repl. 5068004-17	Tine conus 2, straight	1240	M30 x 2	Bale Fork, Bale Fork Mk 1 / S+ / M / L / L+ / XL+, Square Bale Fork, Bale Spike, Flexibal, Silopush, Silopush HX, Manure Fork XL
	5068006-17	Tine conus 1, straight	680	M20 x 1,5	Multi Bale, Silograb MK2, Stone fork (old)
	5068010-17	Tine conus 2, straight	985	M30 x 2	MultiBale, Universal Fork, Silopush, Stone fork Silograb XL, Silocut XL, Manure fork XL
	5068015-1	Tine conus 1, cranked	820	M24 x 2	Silocut, Silocut MG
	5068017	Tine, straight	940	M22 x 1,5	DB 4000
	5068018	Tine, curved	680	-	Multibenne MB
	5068109-17 repl. 5068101-17	Tine conus 1, straight	810	M20 x 1,5	RSB 1200, Bale Spike, Manure Fork, Silograb, Silograb (- 2010), Silograb S+
	5068112-17 repl. 5068102-17	Tine conus 1, curved	680	M20 x 1,5	Multibenne, Multibenne M+ / XL, Multi-grab, Silograb, Silograb (- 2010) / MK2 (tine repl. 5068008), Silograb M+ / XL
	5068117-17 repl. 5068107-17	Tine conus 3, straight	820	M33 x 2	Silocut SG
	1220103	Tine, curved	460	-	DB 2115, DB 2050, DB 2160, DB 2120, DB 3250
	60034749	Weld on tine, straight	949	-	Silograb XL, Silocut XL
	60034750	Weld on tine, straight	1169	-	Silograb XL
	60022809-17	Weld on tine, curved	593	-	Multibenne XL, Silograb XL
	60022782-17	Weld on tine, curved	685	-	Multibenne XL, Silograb XL
	60051290	Weld on tine, curved	623	-	Silograb S+, Multibenne S+



BUCKET TEETH

Our bucket teeth have been specifically design for our buckets, to ensure perfect fit and maximum strength. All teeth have the optimal resistance against wear.



Item no	Description	Size	Fits to
60047175-22	Tooth, orange	For 18 mm cutting edge	SM+ Buckets, HDXL 220 / 240 / 260
60036690-22	Tooth, orange	For 20 mm cutting edge	SL+ Buckets, HDXL 270 / 290
5011559	Nut (2 pcs by tooth)	M20 x 2,5	SM+ / SL+ / SXL+ / HDXL
5002220	Screw (2 pcs by tooth)	M20 x 70	SM+ / SL+ / HDXL
5002212	Screw (2 pcs by tooth)	M20 x 90	SXL+
5013127	Washer (2 pcs by tooth)	BRB 21 x 36 x 3	SM+ / SL+ / SXL+ / HDXL
11260142	Weld on tine	N/A	MPT multipurpose bucket
60036805-22	Tooth, orange	For 25 mm cutting edge	SXL+ Buckets

CUTTING EDGES

You will find below a list of our hardened cutting edges, specially designed for our implements. Other cutting edges types are also available, like Serrated or Polyurethane cutting edges. Visit online spare parts catalogue www.parts.quicke.nu and find them.



Item no	Width	Fits to
11255535Q	160 cm	SM+ / GM+ / GL+ / GXL+ / VL+ Buckets
11255493Q	180 cm	
11255494Q	200 cm	
11255495Q	220 cm	
11255496Q	240 cm	
11255497Q	260 cm	
11255659Q	245 cm	VXL+ Buckets
11255660Q	265 cm	
11255661Q	285 cm	
11255662Q	305 cm	SL+ / HDXL Buckets
11255782Q	220 cm	
11255783Q	240 cm	
11255784Q	260 cm	
11255785Q	270 cm	
11255786Q	290 cm	

Item no	Width	Fits to
11255524Q	90 cm	GS+ Buckets / Multibenne S+
11255525Q	100 cm	
11255527Q	120 cm	
11255528Q	140 cm	
11255529Q	160 cm	





Item no	Width	Fits to
11254153Q	185 cm	Powergrab / Multibenne XL
11254154Q	210 cm	Powergrab / Multibenne XL
11254155Q	240 cm	Powergrab
11254156Q	260 cm	Powergrab
11254826Q	230 cm	Multibenne XL
11254998Q	250 cm	Multibenne XL
60017070	220 cm	Powergrab XL
60016528	240 cm	
60016909	260 cm	
60017116	280 cm	

All kits contain:
Hardened cutting edges HB500 + nuts, screws and washers

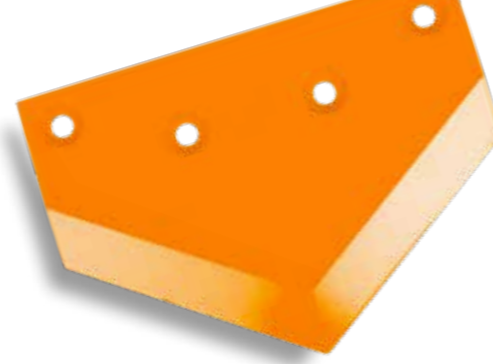
KNIVES FOR SILOCUT

Sharp knives are a key to high efficiency when working with silage. By having a clean cut, it prevents the admission of air and generation of heat, critical for feed quality, while consuming less silage by reducing waste. That's why Ålö now introduce hardened bolt on knives that improves serviceability.



					
Item No	11262627-22	11262628-22	11262629-22	60014466-22	5050610
Description	Corner knife left	Corner knife right	Center knife	Center knife	Screw Mf6s 12 x 20 8.8
Fits to	Silocut SG (2014 08 -), M+ Silocut XL (2018 -), XL+	Silocut SG (201408 -), M+ Silocut XL (2018 -), XL+	Silocut SG (201408 -), M+ Silocut XL (2018 -), XL+	Silocut SG 175	Silocut SG (201408 -), M+ Silocut XL (2018 -), XL+

Note! For replacement knives to previous models of Silocut please visit our spare part viewer at our homepages: www.quicke.nu or www.trima.nu

PALLET FORK LOCKING PINS



Item No	Description	Item No	Description	Note
11262357	Locking pin	11260629	Spring locking kit pallet fork	Replace these four items 841132, 1101017, 501303 and 5016106 with 11260629

HOOKS

Weld on hooks. Euro, Type 3 and SMS



Item No	Description	Item No	Description	Item No	Description	Item No	Description
10830555Q	Euro weld on hooks	10830105	Ålö type 3 weld on hooks	10830440	Trima SMS (5) weld on hooks	830567	Euro weld on hooks

CYLINDER STOP

For extra safety the lift arm support device is recommended to be installed at the lift cylinder rod during service.

Item No	Description
4500930	Safety support Short L = 410 mm
4501259	Safety support Long L = 510 mm



ORIGINAL PARTS BY QUICKE



PROTECT YOUR EQUIPMENT

Original Parts are selected by the same people that designed and manufactured your product and are therefore the best choice for a guaranteed perfect fit and the highest possible quality. This reduces the risk of a "unit down" scenario that prevent you from feeding your cattle or performing other important duties.

SAVE MONEY

Competitor analyses prove that when you select original parts from Quicke you get superior quality that reduces the risk of unexpected downtime. It is absolutely crucial that a part's properties and dimensions work optimally together. Even minor deviations could result in catastrophic and very expensive consequences. Less unplanned repair work during the high season and longer service intervals mean major savings.

FAST DISTRIBUTION

To ensure a high service level we have several warehouses just for spare parts and a well-developed distribution network all over the world. For more information go to www.quicke.nu and www.trima.nu

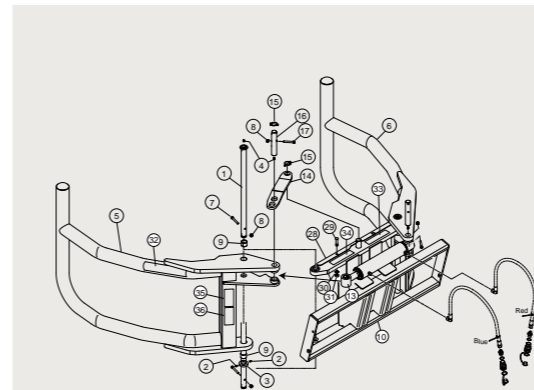

WE'VE GOT SPARE PARTS CLOSE BY EVEN WHEN YOU'RE FAR AWAY!

Spare parts are available for everything from the biggest to the tiniest detail on the implement, and we've got them close by. Our world-leading distribution network guarantees proximity to you, no matter where you are.

All you need to do is contact your local dealer.

Original Parts by Quicke

Original Parts by Quicke

Ålö AB

Member of JOST Agriculture

Brännland 300, SE-901 37 Umeå, Sweden

Tel : +46 (0)90 17 05 00

marketing@alo.se

www.quicke.nu

Version February 2023



142850. Московская область
Малино. ул. Промышленная, вл. 8
Тел. +7 495 198 0175, +7 985 773 7851
E-mail: mosttechnics@gmail.com
<https://most-technics.ru>



CLIMATE
COMPENSATED
PAPER

